

FAN7842

Half Bridge Gate Driver

Features

- Floating Channels Designed for Bootstrap Operation to +200V.
- Typically 350mA/650mA Sourcing/Sinking Current Driving Capability for Both Channels
- Common-Mode dv/dt Noise Canceling Circuit
- Extended Allowable Negative VS Swing to -9V for Signal Propagation @ VCC=VBS=15V
- VCC & VBS Supply Range from 10V to 20V
- UVLO Functions for Both Channels
- TTL Compatible Input Logic Threshold Levels
- Matched Propagation Delay Below 50nsec
- Output In-phase with Input

Applications

- Half and Full Bridge Converters
- Current Fed Push-Pull Converters
- Synchronous Buck Converters

Description

The FAN7842, a monolithic half-bridge gate driver IC, can drive MOSFETs and IGBTs which operate up to +200V. Fairchild's high voltage process and common-mode noise canceling technique provides stable operation of the high-side driver under high dv/dt noise circumstances. An advanced level shift circuit allows high-side gate driver operation up to $V_S = -9.8$ V(typ.) for $V_{BS} = 15$ V. The input logic level is compatible with standard TTL-series logic gates. UVLO circuits for both channels prevent malfunction when VCC and VBS are lower than the specified threshold voltage. Output driver current(source/sink) is typically 350mA/650mA, respectively.

8 SOP



1

Ordering Information

Part Number	Operating Temp. Range	Pb-Free	Package	Packing Method
FAN7842M	-40°C to +125°C	Yes	8-SOP	Tube
FAN7842MX				Tape & Reel

Typical Application Diagram

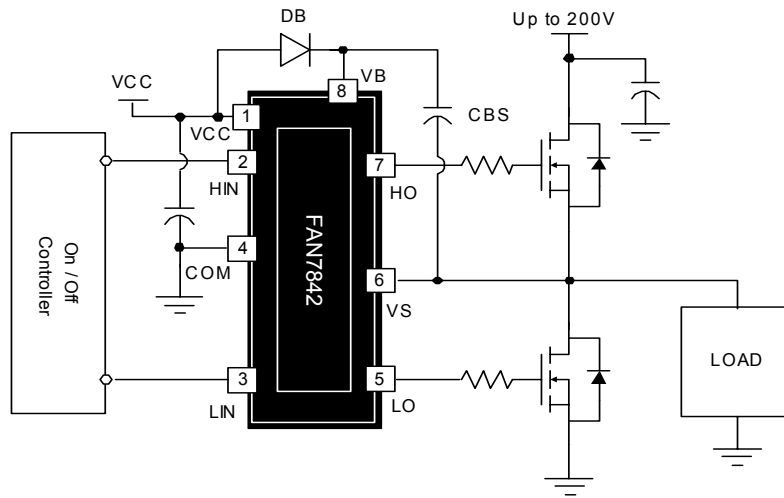

Internal Block Diagram

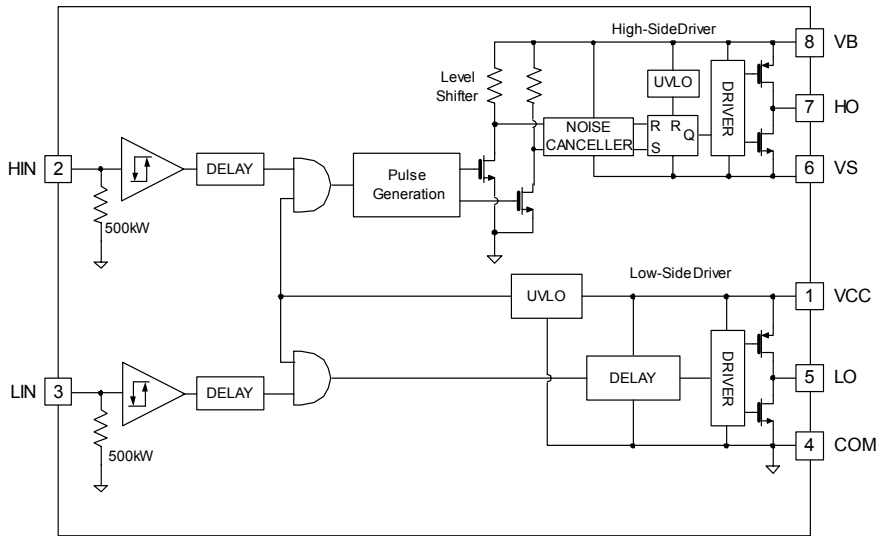

Pin Assignments

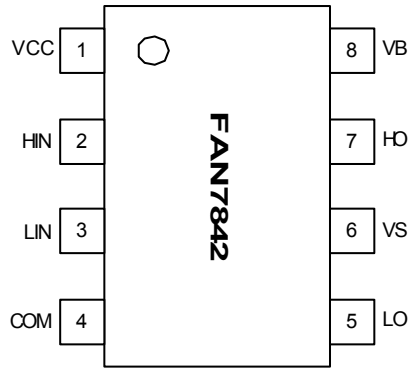

Pin Definitions

Pin Number	Pin Name	I/O	Pin Function Description
1	VCC	I	Low Side Supply Voltage
2	HIN	I	Logic Input for High Side Gate Driver Output
3	LIN	I	Logic Input for Low Side Gate Driver Output
4	COM	-	Logic Ground and Low Side Driver Return
5	LO	O	Low Side Driver Output
6	VS	I	High Voltage Floating Supply Return
7	HO	O	High Side Driver Output
8	VB	I	High Side Floating Supply

Absolute Maximum Ratings

Parameter	Symbol	Min.	Max.	Unit
High side offset voltage	VS	VB-25	VB+0.3	V
High side floating supply voltage	VB	-0.3	225	
High side floating output voltage HO	V _{HO}	VS-0.3	VB+0.3	
Low side and logic fixed supply voltage	VCC	-0.3	25	
Low side output voltage LO	V _{LO}	-0.3	VCC+0.3	
Logic input voltage(HIN, LIN)	V _{IN}	-0.3	VCC+0.3	
Logic ground	COM	VCC-25	VCC+0.3	
Allowable offset voltage SLEW RATE	dVs/dt		50	V/ns
Power dissipation	P _D	-	0.625	W
Thermal resistance, junction to ambient	R _{thja}	-	200	°C/W
Junction temperature	T _J		150	°C
Storage temperature	T _S		150	°C

Note:

Absolute maximum ratings indicate sustained limits beyond which damage to the device may occur. All voltage parameters are absolute voltage referenced to COM, all currents are defined positive into any lead.

Recommended Operating Ratings.

Parameter	Symbol	Min.	Max.	Unit
High side floating supply voltage	VB	VS+10	VS+20	V
High side floating supply offset voltage	VS	6-VCC	200	
High side(HO) output voltage	V _{HO}	VS	VB	
Low side(LO) output voltage	V _{LO}	COM	VCC	
Logic input voltage(HIN, LIN)	V _{IN}	COM	VCC	
Low side supply voltage	VCC	10	20	
Ambient temperature	T _A	-40	125	°C

ESD Level

Parameter	Pins	Conditions	Level	Unit
Human Body Model (HBM)	All Pins	R=1.5kΩ, C=100pF	±2000	V
Machine Model (MM)		C=200pF	±300	
Charged Device Model (CDM)			±500	

Note :

The human body model is a 100pF capacitor discharged through a 1.5k resistor into each pin. Pin6,Pin7 and Pin8 are rated at ±1500V.

Electrical Characteristics

($V_{BIAS}(V_{CC}, V_{BS})=15.0V$, $T_A = 25^\circ C$, unless otherwise specified. The V_{IN} , V_{TH} and I_{IN} parameters are referenced to COM. The V_O and I_O parameters are referenced to COM and VS is applicable to HO and LO.)

Parameter	Symbol	Condition	Min.	Typ.	Max.	Unit
VCC and VBS supply under voltage positive going threshold	VCCUV+ VBSUV+	-	8.2	9.2	10.0	V
VCC and VBS supply under voltage negative going threshold	VCCUV- VBSUV-	-	7.6	8.7	9.6	
VCC supply under voltage lockout hysteresis	VCCUVH VBSUVH	-	-	0.6	-	
Offset supply leakage current	I_{LK}	VB=VS=200V	-	-	10	uA
Quiescent VBS supply current	I_{QBS}	$V_{IN}=0V$ or 5V	-	45	120	
Quiescent VCC supply current	I_{QCC}	$V_{IN}=0V$ or 5V	-	70	180	
Operating VBS supply current	I_{PBS}	$f_{in}=20kHz$, rms value	-	-	600	uA
Operating VCC supply current	I_{PCC}	$f_{in}=20kHz$, rms value	-	-	600	
Logic "1" input voltage	V_{IH}	-	2.9	-	-	V
Logic "0" input voltage	V_{IL}	-	-	-	0.8	
High level output voltage, VBIAS-VO	V_{OH}	$I_O=20mA$	-	-	1.0	
Low level output voltage, VO	V_{OL}		-	-	0.6	
Logic "1" input bias current	I_{IN+}	$V_{IN}=5V$	-	10	20	uA
Logic "0" input bias current	I_{IN-}	$V_{IN}=0V$	-	1.0	2.0	
Output high short circuit pulse current	I_{O+}	$V_O=0V$, $V_{IN}=5V$ with $PW<10\mu s$	250	350	-	mA
Output low short circuit pulsed current	I_{O-}	$V_O=15V=VB$, $V_{IN}=0V$ with $PW<10\mu s$	500	650	-	
Allowable negative VS pin voltage for HIN signal propagation to HO	VS	-	-	-9.8	-7	V

Dynamic Electrical Characteristics

$V_{BIAS}(V_{CC}, V_{BS})=15.0V$, $VS=GND$, $CL=1000pF$ and $TA=25^\circ C$, unless otherwise specified.

Parameter	Symbol	Conditions	Min.	Typ.	Max.	Unit
Turn-on propagation delay	t_{on}	VS=0V	100	170	300	ns
Turn-off propagation delay	t_{off}	VS=0V	100	200	300	
Turn-on rise time	t_r	-	20	60	140	
Turn-off fall time	t_f	-	-	30	80	
Delay matching, HS & LS turn-on/off	MT	-	-	-	50	

Typical Performance Characteristics

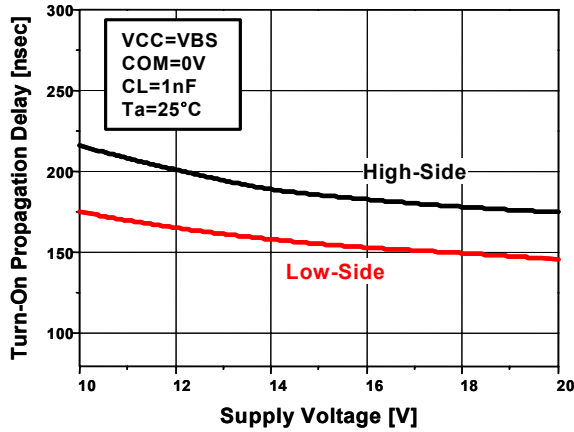

Figure 1. Turn-On Propagation Delay vs. Supply Voltage

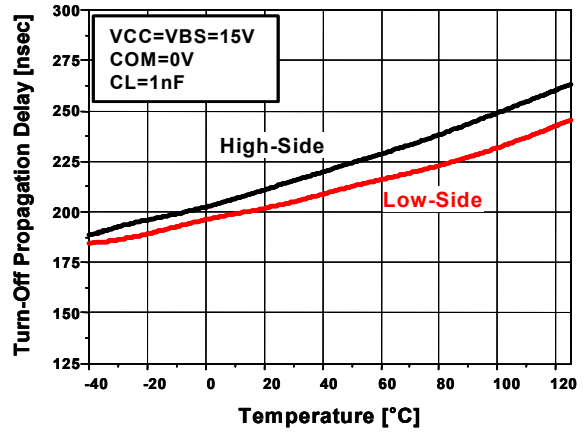

Figure 4. Turn-Off Propagation Delay vs. Temp.

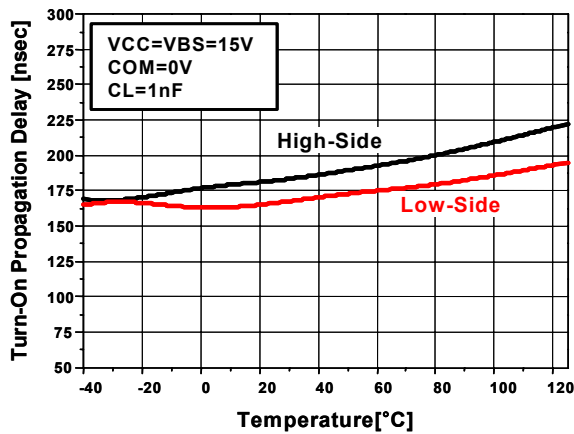

Figure 2. Turn-On Propagation Delay vs. Temp.

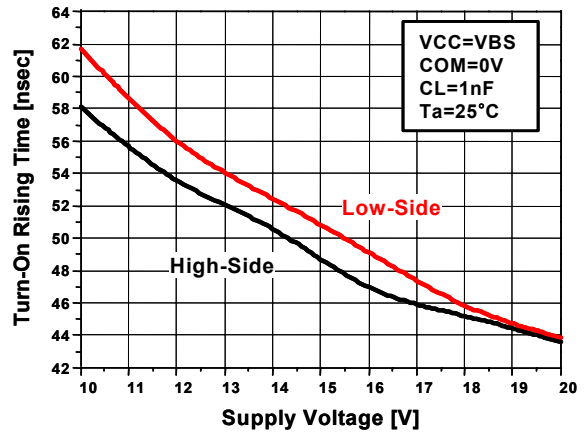

Figure 5. Turn-On Rising Time vs. Supply Voltage

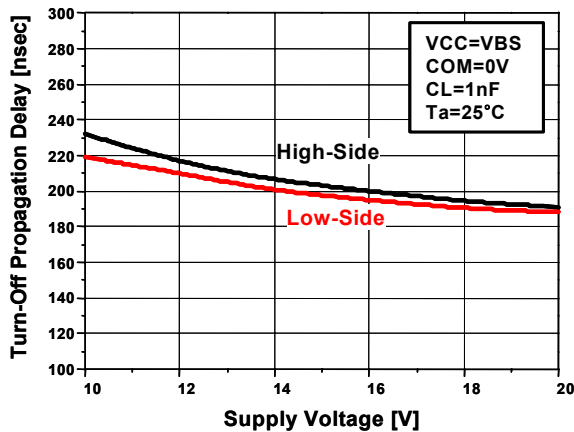

Figure 3. Turn-Off Propagation Delay vs. Supply Voltage

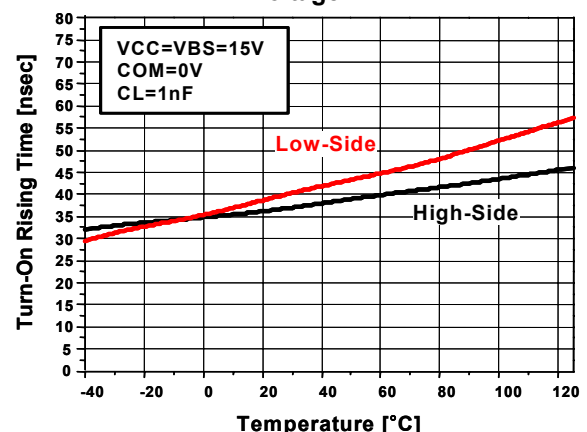

Figure 6. Turn-On Rising Time vs. Temp.

Typical Performance Characteristics (Continued)

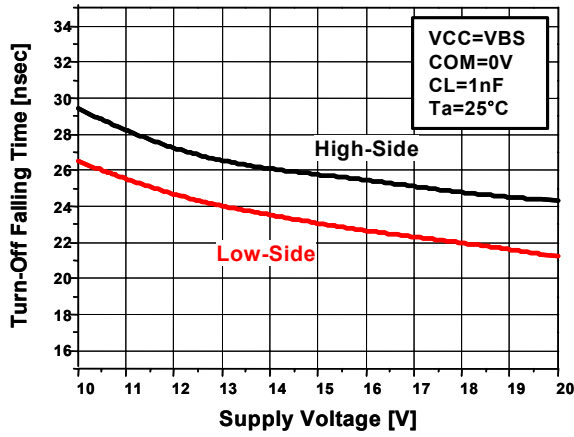

Figure 7. Turn-Off Falling Time vs. Supply Voltage

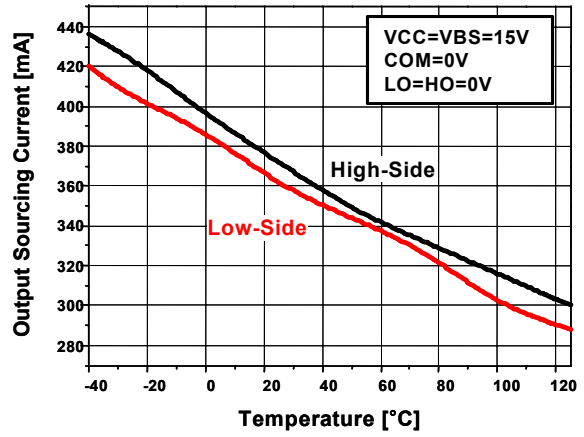

Figure 10. Output Sourcing Current vs. Temp.

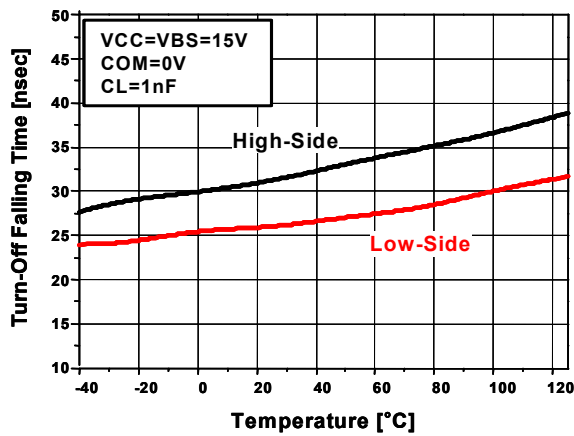

Figure 8. Turn-Off Falling Time vs. Temp.

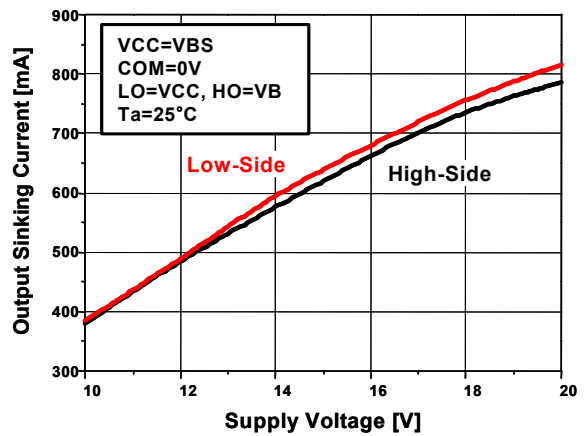

Figure 11. Output Sinking Current vs. Temp.

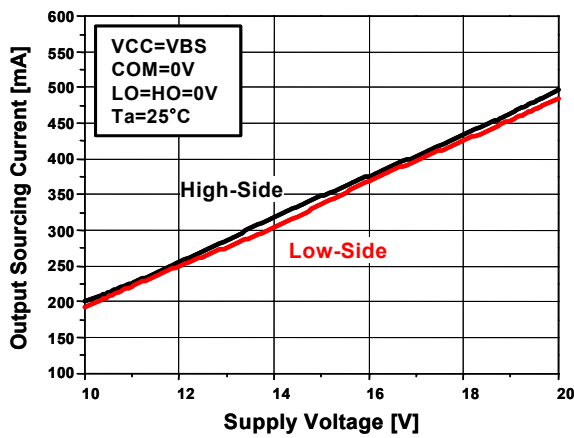

Figure 9. Output Sourcing Current vs. Supply Voltage

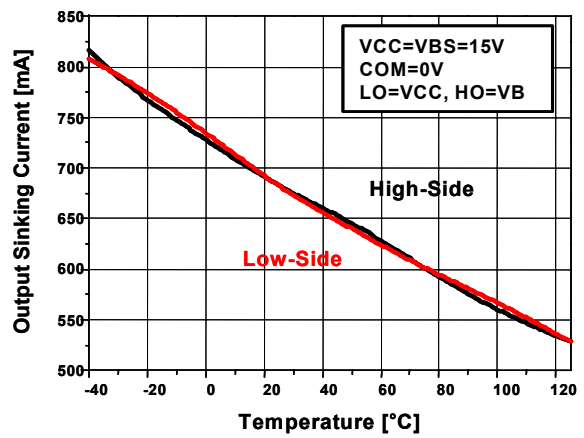

Figure 12. Output Sinking Current vs. Temp.

Typical Performance Characteristics (Continued)

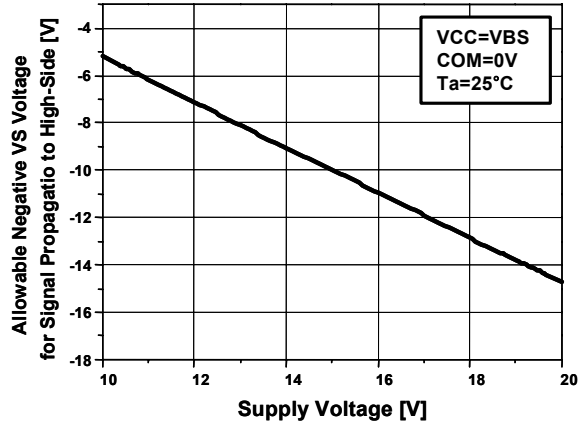

Figure13. Allowable Negative VS Voltage for Signal Propagation to High Side vs. Supply Voltage

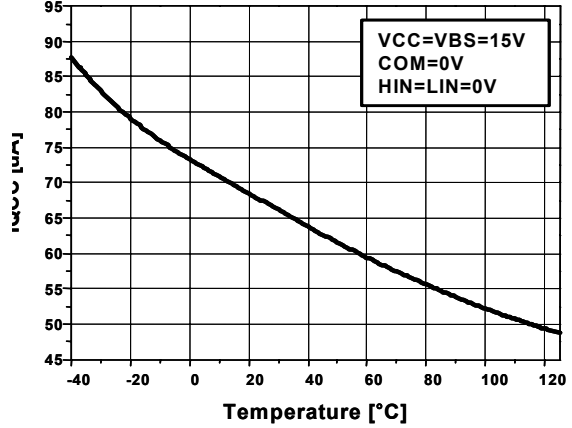

Figure16. IQCC vs. Temperature

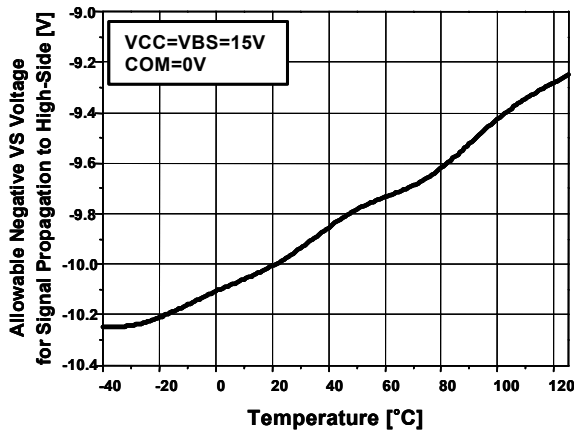

Figure14. Allowable Negative VS Voltage for Signal Propagation to High Side vs. Tem.

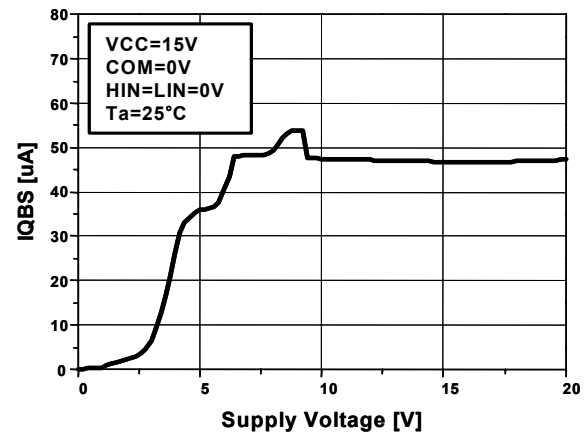

Figure17. IQBS vs. Supply Voltage

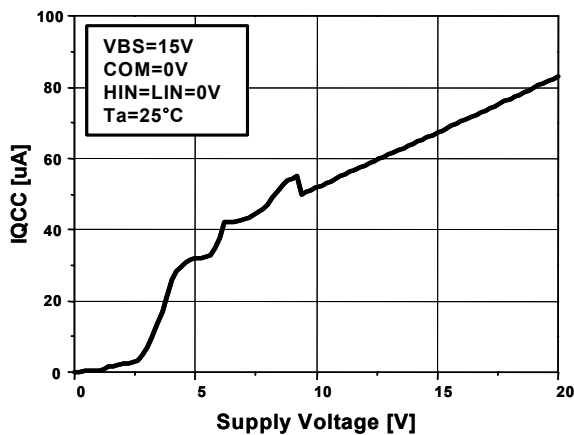

Figure15. IQCC vs. Supply Voltage

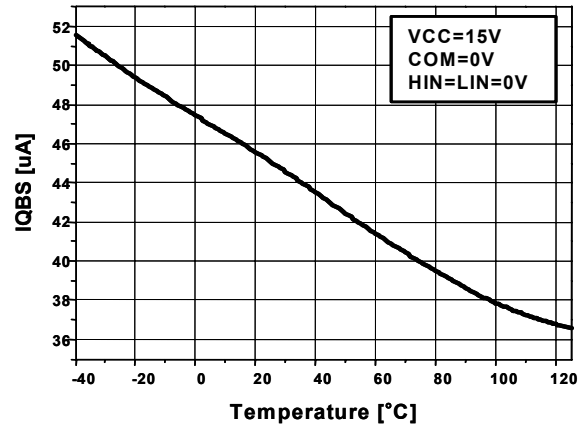

Figure18. IQBS vs. Temperature

Typical Performance Characteristics (Continued)

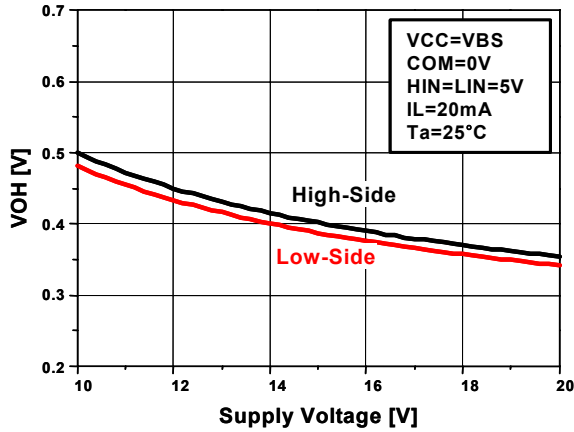

Figure 19. High Level Output Voltage vs. Supply Voltage

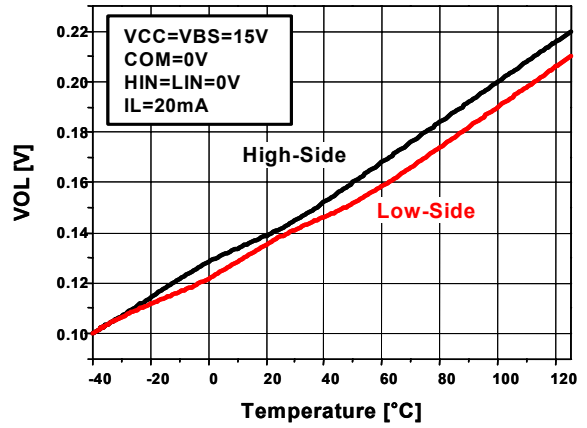

Figure 22. Low Level Output Voltage vs. Temp.

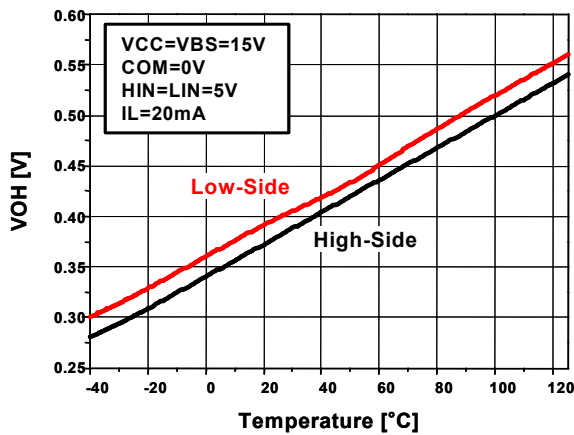

Figure 20. High Level Output Voltage vs. Temp.

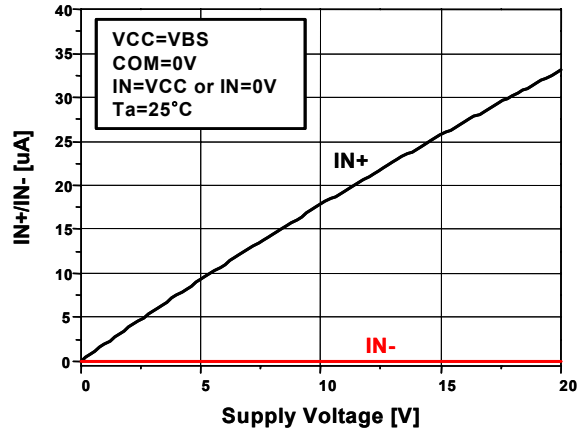

Figure 23. Input Bias Current vs. Supply Voltage

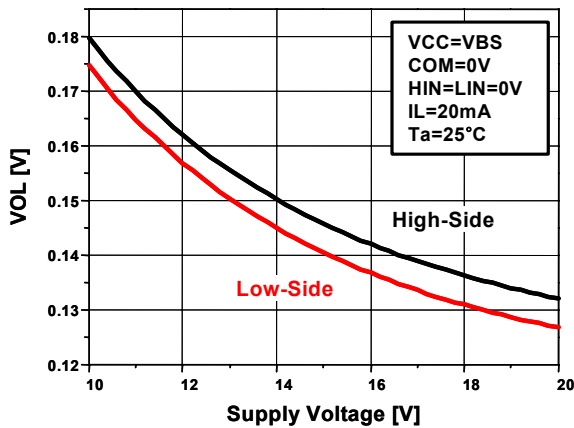

Figure 21. Low Level Output Voltage vs. Supply Voltage

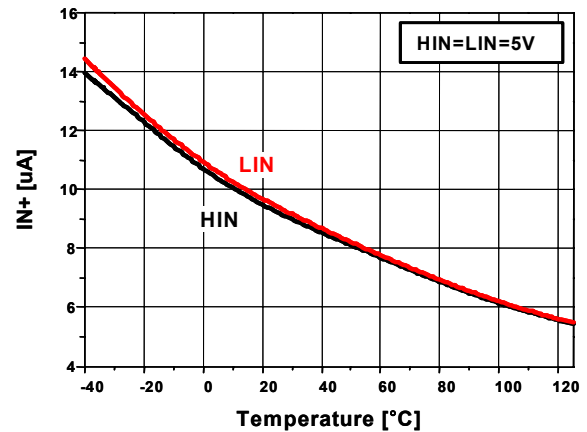

Figure 24. Input Bias Current vs. Temp.

Typical Performance Characteristics (Continued)

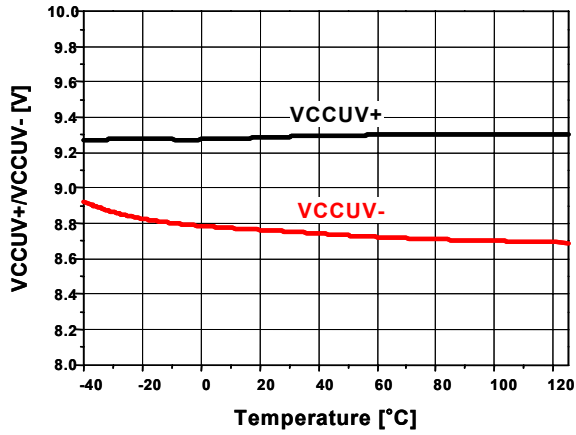

Figure 25. VCC UVLO Threshold Voltage vs. Temp.

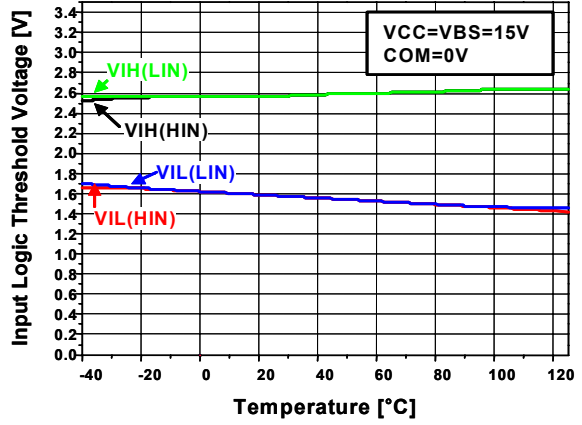

Figure 28. Input Logic Threshold Voltage vs. Temp.

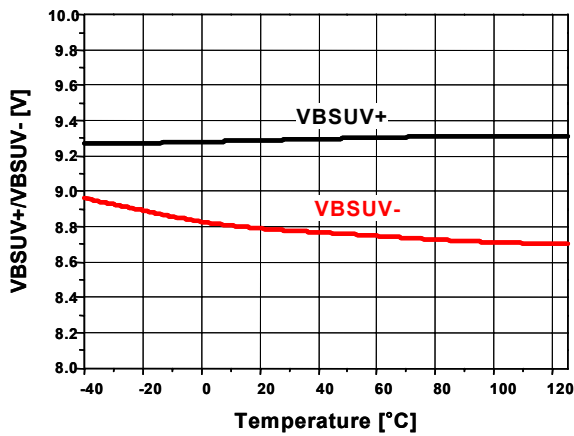

Figure 26. VBS UVLO Threshold Voltage vs. Temp.

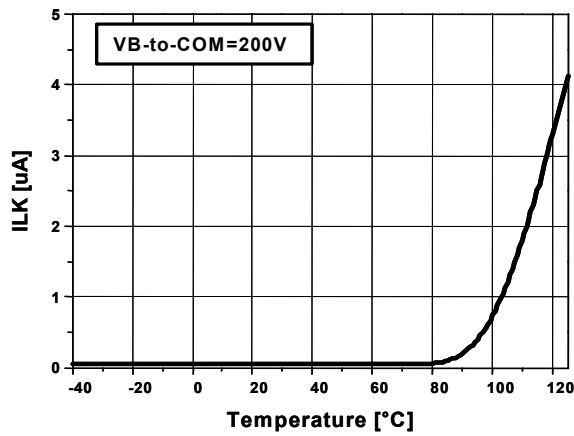

Figure 27. VB to COM Leakage Current vs. Temp.

Applications Information

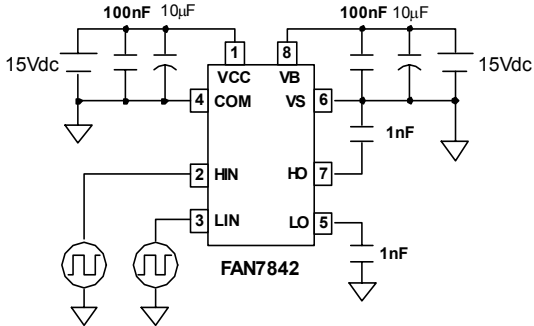

Figure 29. Switching Time Test Circuit

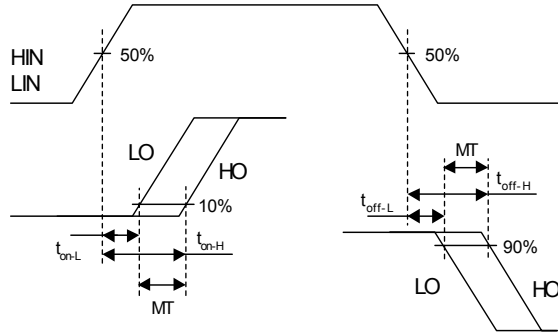

Figure 32. Delay Matching Waveform Definition

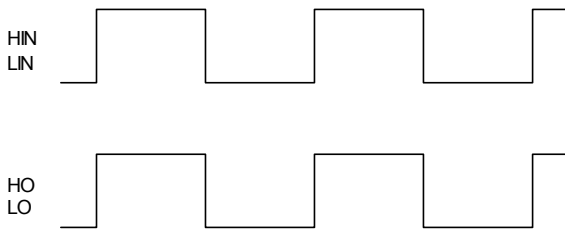

Figure 30. Input / Output Timing Diagram

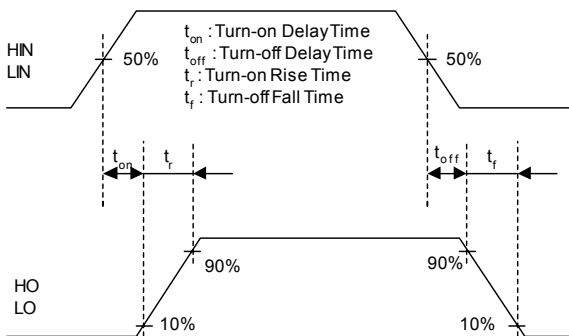

Figure 31. Switching Time Waveform Definitions

Mechanical Dimensions

8-SOP

Dimensions in millimeters

**8-Lead Small Outline IC (SOIC) 0.150" Body Width
Package Dimensions**



**8-Lead Small Outline IC (SOIC)
0.150" Body Width**

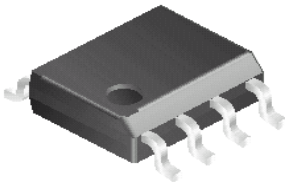

Symbol	Inches		Millimeters		Notes
	Min.	Max.	Min.	Max.	
A	.053	.069	1.35	1.75	
A1	.004	.010	0.10	0.25	
B	.013	.020	0.33	0.51	
C	.0075	.010	0.20	0.25	5
D	.189	.197	4.80	5.00	2
E	.150	.158	3.81	4.01	2
e	.050 BSC		1.27 BSC		
H	.228	.244	5.79	6.20	
h	.010	.020	0.25	0.50	
L	.016	.050	0.40	1.27	3
N	8		8		6
α	0°	8°	0°	8°	
ccc	—	.004	—	0.10	

Notes:

1. Dimensioning and tolerancing per ANSI Y14.5M-1982.
2. "D" and "E" do not include mold flash. Mold flash or protrusions shall not exceed .010 inch (0.25mm).
3. "L" is the length of terminal for soldering to a substrate.
4. Terminal numbers are shown for reference only.
5. "C" dimension does not include solder finish thickness.
6. Symbol "N" is the maximum number of terminals.

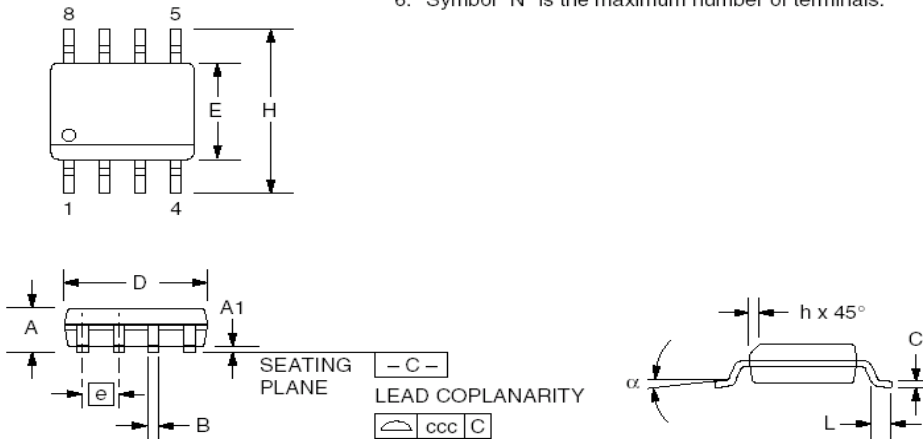

TRADEMARKS

The following are registered and unregistered trademarks Fairchild Semiconductor owns or is authorized to use and is not intended to be an exhaustive list of all such trademarks.

ACEx™	FAST®	ISOPLANAR™	PowerSaver™	SuperSOT™-6
ActiveArray™	FASTr™	LittleFET™	PowerTrench®	SuperSOT™-8
Bottomless™	FPST™	MICROCOUPLER™	QFET®	SyncFET™
Build it Now™	FRFET™	MicroFET™	QS™	TinyLogic®
CoolFET™	GlobalOptoisolator™	MicroPak™	QT Optoelectronics™	TINYOPTO™
CROSSVOLT™	GTO™	MICROWIRE™	Quiet Series™	TruTranslation™
DOME™	HiSeC™	MSX™	RapidConfigure™	UHC™
EcoSPARK™	I ² C™	MSXPro™	RapidConnect™	UltraFET®
E ² C MOS™	i-Lo™	OCX™	μSerDes™	UniFET™
EnSigna™	ImpliedDisconnect™	OCXPro™	ScalarPump™	VCX™
FACT™	IntelliMAX™	OPTOLOGIC®	SILENT SWITCHER®	Wire™
FACT Quiet Series™		OPTOPLANAR™	SMART START™	
Across the board. Around the world.™		PACMAN™	SPM™	
The Power Franchise®		POP™	Stealth™	
Programmable Active Droop™		Power247™	SuperFET™	
		PowerEdge™	SuperSOT™-3	

DISCLAIMER

FAIRCHILD SEMICONDUCTOR RESERVES THE RIGHT TO MAKE CHANGES WITHOUT FURTHER NOTICE TO ANY PRODUCTS HEREIN TO IMPROVE RELIABILITY, FUNCTION OR DESIGN. FAIRCHILD DOES NOT ASSUME ANY LIABILITY ARISING OUT OF THE APPLICATION OR USE OF ANY PRODUCT OR CIRCUIT DESCRIBED HEREIN; NEITHER DOES IT CONVEY ANY LICENSE UNDER ITS PATENT RIGHTS, NOR THE RIGHTS OF OTHERS.

LIFE SUPPORT POLICY

FAIRCHILD'S PRODUCTS ARE NOT AUTHORIZED FOR USE AS CRITICAL COMPONENTS IN LIFE SUPPORT DEVICES OR SYSTEMS WITHOUT THE EXPRESS WRITTEN APPROVAL OF FAIRCHILD SEMICONDUCTOR CORPORATION. As used herein:

1. Life support devices or systems are devices or systems which, (a) are intended for surgical implant into the body, or (b) support or sustain life, or (c) whose failure to perform when properly used in accordance with instructions for use provided in the labeling, can be reasonably expected to result in significant injury to the user.
2. A critical component is any component of a life support device or system whose failure to perform can be reasonably expected to cause the failure of the life support device or system, or to affect its safety or effectiveness.

PRODUCT STATUS DEFINITIONS

Definition of Terms

Datasheet Identification	Product Status	Definition
Advance Information	Formative or In Design	This datasheet contains the design specifications for product development. Specifications may change in any manner without notice.
Preliminary	First Production	This datasheet contains preliminary data, and supplementary data will be published at a later date. Fairchild Semiconductor reserves the right to make changes at any time without notice in order to improve design.
No Identification Needed	Full Production	This datasheet contains final specifications. Fairchild Semiconductor reserves the right to make changes at any time without notice in order to improve design.
Obsolete	Not In Production	This datasheet contains specifications on a product that has been discontinued by Fairchild semiconductor. The datasheet is printed for reference information only.